

MultiCoat Pro Advanced Thermal Spray Coating Platform

The MultiCoat™ Pro by Oerlikon Metco brings the benefits of unlimited versatility and unmatched process control.

With MultiCoat Pro you will have:

- Up to five different atmospheric thermal spray processes in one booth, thereby maximizing your investment and minimizing the use of valuable shop floor space
- The ability to have a controlled atmosphere spray system with the most modern features
- Up to eight powder feeders that can be used individually or concurrently
- Unlimited design possibilities for gun and part handling systems, including multiple part stations in one system
- Our new Clarity™ User Interface that guides operators through the entire spray process and provides unprecedented quality control, diagnostics and safety functions

- MultiCoat Pro changes as your needs change with its modular hardware and software design concept, that simplifies the addition or change of software features, components and/or processes.
- A system ready for your smart factory with Industry 4.0 (IIoT)

Choice of Traditional Cabinetry or Process Cube

Customers can choose from a traditional thermal spray configuration with processes housed in standalone cabinets, or choose the new Process Cube design.

The Process Cube houses many of the core thermal spray processes within a space-saving, pretested cube that is quickly installed at the customer's facility. It sits next to or behind the thermal spray booth and includes:

- Process management
- Gas management
- Power supply
- Universal junction & monitoring unit
- Electrical distribution
- Heat exchanger with gun cooling circuits



MultiCoat Pro with robot and 12-station indexing turntable

1 General Description

A MultiCoat Pro thermal spray system can control up to 5 thermal spray processes in one system:

- **APS** (Atmospheric Plasma Spray with single or triple cathode spray guns)
- **HVOF-LF** (Liquid-Fuel High Velocity Oxy-Fuel Spray)
- **HVOF-GF** (Gas-Fuel High Velocity Oxy-Fuel Spray)
- **CPS** (Combustion Powder Thermospray™)
- **CWS** (Combustion Wire Spray)

Customers can initially order their MultiCoat Pro system with just the processes they require and add additional processes in the future.

MultiCoat Pro can also be configured as a ChamPro™ controlled-atmosphere spray system consisting of one of the following processes:

- VPS
- LPPS or LVPS
- LPPS Hybrid

Please refer to the table below for main system components needed for each spray process, and refer to Section 2 for customer-configurable choices.

1.1 User Interface

The MultiCoat Pro system platform employs our Clarity User Interface, which has been totally reimaged for ultimate us-

ability and safety. Previous owners of MultiCoat systems will be pleased to know that many formerly optional software features are now standard in Clarity. A detailed description of the Clarity User Interface is provided later in this document.

1.2 Material Feeders

MultiCoat Pro can have up to eight powder feeders that can be run simultaneously or independently depending on the spray application (see Section 3.4). For combustion wire spray, one wire stand will be supplied.

1.3 Handling Systems

Oerlikon Metco welcomes the challenge of creating a MultiCoat Pro system tailored for your specific requirements.

Spray gun and part handling is completely customizable to the customer's specific needs by our Systems Engineering team. Oerlikon Metco can design these handling systems in practically any configuration and combination that ensures cost- and time-efficient thermal spray processing of parts. This makes the MultiCoat Pro system platform the most flexible and versatile choice for thermal spraying.

































In addition to a variety of turntable designs, headstock-tailstock units and robots, completely unique concepts are possible, including multiple part handling stations in one spray booth and 'just-in-time' in-line systems for series production.

System Components	APS	HVOF-LF	HVOF-GF	CPS	CWS ^a	ChamPro ^a
Clarity User Interface	✓	✓	✓	✓	✓	✓
Spray Gun(s)	✓	✓	✓	✓	✓	✓
Powder Feeder(s)	✓	✓	✓	✓	✗	✓
Wire Stand	✗	✗	✗	✗	✓	✗
Process Management	✓	✓	✓	✓	✓	✓
Process Media Management (gas / liquid)	✓	✓	✓	✓	✓	✓
Electrical Distribution	✓	✓	✓	✓	✓	✓
JAMBox	✓	✓	✓	✓	✓	✓
PTPro Power Supply(s)	✓	✗	✗	✗	✗	✓
Water Cooling System ^b	✓	✓	✓	✗	✗	✓
Acoustical Enclosure	✓	✓	✓	✓	✓	✗
Vacuum Chamber	✗	✗	✗	✗	✗	✓
Atmosphere Control System	✗	✗	✗	✗	✗	✓
Exhaust and Filtration System	✓	✓	✓	✓	✓	✓
Spray Gun Manipulation	✓	✓	✓	✓	✓	✓
Workpiece Manipulation	✓	✓	✓	✓	✓	✓

^a In development. Please ask your Oerlikon Metco Account Representative for more information on availability

^b May be supplied by the customer if facility cooling water is available

2 Customer Configurable Choices

	ChamPro ^a	APS	HVOF-GF	HVOF-LF	CPS	CWS ^a
Clarity User Interface			 Single Monitor (standard)	 Dual Monitor (optional)		
Monitor Mounts^b			 Extension Arm	 Wheeled Stand		
Spray Gun^c	 SinplexPro 03C  F4-VB	 TriplexPro-210  F4MB-XL  Metco 3MBM	 SinplexPro  Diamond Jet 2600  Diamond Jet 2700  Diamond Jet Vortex ID-125	 WokaStar-610-Sz  WokaJet-410-Sz	 Metco 6P-II-A	 Metco EGD-K
Material Feeders			 Single Pro Series	 Metco 9MPE-CL Series		 Metco 2W
Process Management^d			 Process Controller			
Gas Management^d			 Gas Module			
Power Supply^d	 Metco PTPro 120 (high profile)	 Metco PTPro 120 (low profile)	 Metco PTPro 45 (high profile)	---	---	---
Junction & Monitoring^d	 Junction & Monitoring Unit ChamPro	 Universal Junction & Monitoring Unit	 Junction & Monitoring Unit HVOF			
Electrical Distribution^d			 Standard	 Optional with Fuse Supervision / Energy Monitor		
Heat Exchanger^d		 MC HE	 MC Chiller		---	---

^a In development. Please ask your Account Representative for information on availability.

^b Shown with double monitors, Single monitor mounts also available.

^c Other spray guns available on request.

^d Installed as frame-mounted hardware with Process Cube option, otherwise, provided in traditional cabinets.

3 System Component Description

3.1 Clarity User Interface



The Clarity User Interface simplifies your production process and enables an easier, faster and more efficient operation. Your company benefits from the intuitive, customizable user interface and integrated operator guidance that reduces learning curves and error potential.

The Clarity user interface is supplied standard with one 21-inch touchscreen, portrait-mode monitor or optionally with two 21-inch touchscreen, portrait-mode monitors, where the second monitor is available to display informational data such as live trending data, instruction manuals, alarm history, etc. An on-screen keyboard allows entry of alphanumeric values.

Clarity is your complete thermal spray data and control environment rather than an ordinary Human-Machine Interface. Clarity integrates your entire production line into an Industry 4.0 (IIoT) environment via Clarity's optional Production Manager (see Section 6.1).

Clarity guides the operator through the entire thermal spray process, using a well-structured and very logical on-screen presentation and interface.

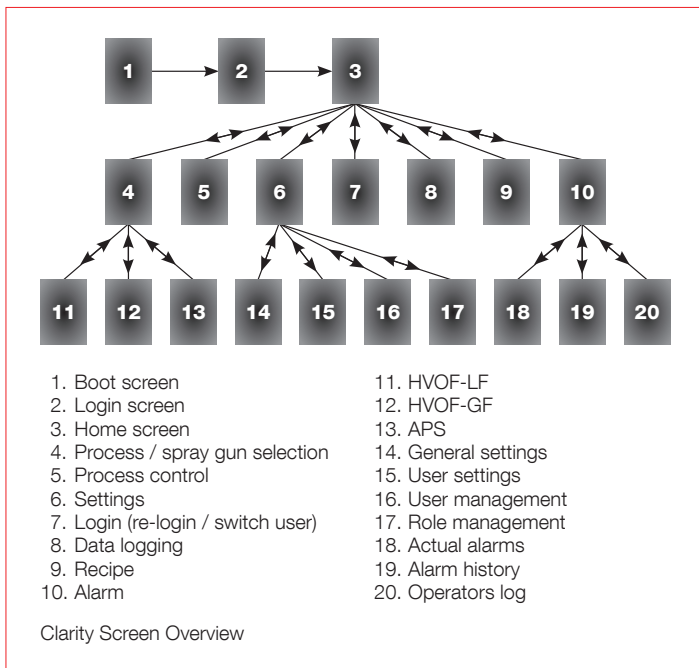

3.1.1 Multi-Level Login and Security

Every aspect of Clarity is completely integrated for streamlined functionality and operation. This starts with the Multi-Level Login and Security features.

Clarity allows each user's permissions to be specifically defined based on your specific operational needs. These permissions can be securely stored and accessed using a

methodology that best suits your company's IT security protocols and infrastructure. You can choose to have users sign in via:

- On-screen keyboard
- RFID
- USB (available on request)

Credentials can be saved locally on the system via a local user database, or credentials can be managed via an external database such as Microsoft SQL or Active Directory (or other database systems on request), without the need to store credentials locally within the system. This flexible solution offers the following scenarios:

- **Dedicated server / dedicated database:** For each instance of Clarity, a dedicated server with a dedicated user database on the network.
- **Shared server / dedicated database:** A shared server using a dedicated per system database fully separates user information between systems.
- **Dedicated server / shared database:** This option simplifies user login on multiple systems, using a shared user database. Once a user is registered in the database, that user can login with the same credentials on all participating systems.

3.1.2 Home screen

The home screen guides the operator through the major functions of the Clarity user interface via a series of tiles. Tiles are color-coded to help guide the operator:

- Green: Processing functions
- Yellow: Clarity system functions
- Blue: Data and monitoring functions

3.1.3 Process and Spray Gun Selection

The Process and Spray Gun Selection screen allows the addition, editing or deletion of a specific thermal spray gun to the MultiCoat Pro system by personnel with appropriate credentials. Each spray gun configuration is controlled by a unique system ID. Only activated spray guns can be used for spray processing and saved in parameter recipes.

Selection of a spray gun also prompts the user to activate the appropriate thermal spray process. Clarity first confirms that the appropriate spray process is installed on the system. If it is not, the user is alerted and the spray gun cannot be activated.

Once activated, the user can enter specific information for that spray gun, including serial number. During use of that gun, Clarity tracks ignitions and running hours for the spray gun to aid in maintenance and cost control.

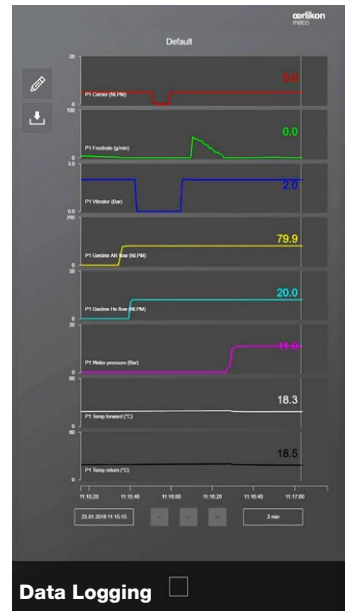
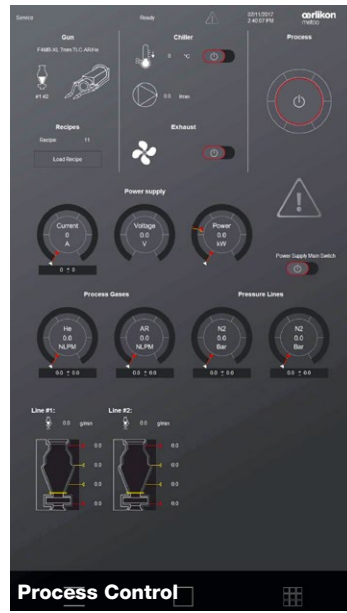
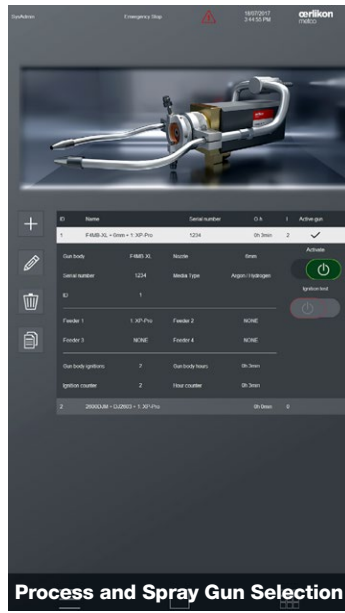

Examples of Clarity User Interface Screens

3.1.4 Process Control

From the process screen, operators can:

- Load a previously saved thermal spray recipe
- Start and stop the process
- Start and stop the chiller
- Start and stop the exhaust system
- Start, stop and monitor material feeders
- Open the alarm page
- Set parameter values, tolerances and limits
- Change process media (where appropriate)
- Change the display units (metric or U.S. Customary)

Clarity keeps the operator fully informed as to process status at all times and makes it simple to enter parameter values.

The settings shown on the process control screen will change based on the spray gun and process type chosen. Clarity will only show those items pertinent to that spray gun and process. In addition, the process screen will only indicate the number and type of powder feed lines available.

Items that are depicted with an analog value display (such as process gases) show the media being used, the set value and the actual measured value. Configurable tolerance settings are visualized in yellow for warnings and red for critical conditions.

Slider bars are used to turn on and off items such as the chiller, exhaust and power supply. These display red when fully off, green when fully on, and yellow while turning on or off.

Powder line status is similarly shown. Visualized are the line identification, the actual feed rate, the feed rate range, the status of the feeder (hopper), feed rate status and indicators for carrier gas type and flow. Depending on the feeder technology being used, other settings and indicators are shown.

When Metco XP Pro feeders are used, the powder level is also tracked, where a low level will trigger a system shut down that must be rectified prior to restart.

Recipes based on the values set on this screen can be saved for future recall and use. Recipes can also be exported and imported from other instances of Clarity.

3.1.5 Global and User Settings

With the appropriate credentials, a number of things can be changed on the global settings screen that include:

- Alarm history retention
- The system default language in English or German (other languages on request)
- The default unit system (metric or U. S. Customary)
- The keyboard language
- Default tolerances
- Default limits
- System backup time and path
- Trend storage duration

Some global settings can be overridden for individual users on the user setting screen. These are:

- Language
- Keyboard language
- Unit system

3.1.6 User and Role Management

On the user management screen, a new user can be added to or removed from the system. Information includes:

- User name
- User ID (generated automatically)
- Password
- Role

Roles are set up via the role management screen.

Companies can set up as many different roles as is needed for their security and operation.

Clarity allows for unprecedented granularity as to what various roles can or cannot do. Furthermore, roles can be later edited or deleted should needs change. Should an existing user's role be deleted from Clarity, that user will be locked out of the system until a new role is chosen for that user in the user management area.

3.1.7 Data Logging

Clarity tracks practically all spray process data. The user can configure up to 10 trend lines at any time, and the operator can choose up to 8 of those trend lines to display on screen.

Trend data can be customized by:

- Parameter data to be sampled
- Trending curve color
- Y-axis scale
- Displayed unit

The time scale (x-axis) for all trend lines can be instantaneously changed from as small as 1 minute up to 24 hours. Past values are easily viewed on screen using arrows, and the user can get back to the current time at the touch of a button.

Trend data values are easily exported with time stamps making it simple to compare data by completed part, run, day, week or other time frame up to a month or the retention time interval set on the settings screen.

3.1.8 Recipe Screen

Up to 10000 thermal spray recipes can be saved in Clarity. Each criteria on screen, such as recipe name, process type and spray gun, makes it easy to find saved recipes.

Recipes can be created, edited or deleted from the recipe screen by users with appropriate credentials. In addition, a previously saved recipe is easily copied as the basis for a new recipe.

Clarity can import recipes from another MultiCoat Pro system; however, Clarity will analyze and validate the imported recipe before it can be used. It provides a validation report with an action for each parameter. Recipes can also be exported for use on another MultiCoat Pro system.

3.1.9 Alarms

With Clarity, responding to alarms is easier than ever before. Alarms are categorized as a warning or fatal event. A simple click on the alarm opens additional information. Alarm status is also easier to track via a color-coded system:

- Red: Alarm is pending (operator has not yet confirmed)
- Yellow: Alarm has been confirmed by the operator. It will be removed automatically upon resolution of the condi-

tion that triggered the alarm.

- Green: Triggering condition that caused the alarm is no longer pending and will be removed automatically when confirmed by the operator.

Alarms can be filtered by type (warning or fatal) and status.

All alarms are retained in the alarm history for a period of up to 30 days. Historical alarms can be exported.

3.1.10 Operators Log

A log file is maintained of all users who have logged into the system for a maximum of 6 months. An audit trail of user actions can be turned on or off. If on, the audit trail is saved permanently within the system. Both the log file and the audit trail can be exported, if desired.

3.2 Monitor Mount



Customers can choose from two options to mount the monitors for the Clarity user interface:

- Floor stand with wheels
- Extension arm with multiple positioning axes that allow the operator to position the screen at a comfortable height and viewing angle.

Either option allows the operator to conveniently position the monitors when they are to be used or move them out of the way. They are available for both the single- and dual-screen options.

3.3 Thermal Spray Guns



The MultiCoat Pro system is capable of operating Oerlikon Metco's most popular machine-mounted thermal spray guns, dependent on the thermal spray processes installed.

When a MultiCoat Pro spray recipe is developed, the spray gun chosen is integrated into the recipe. The Clarity user interface automatically sets operating limits for the installed spray gun.

In addition, Clarity will only allow the recipe to be developed and the system to operate with the installed and operational process gases appropriate for the spray process and the spray gun (see Section 3.1.3).

Clarity's preventative maintenance capability provides information on when a spray gun's consumable and wear parts should be replaced. Thus, quality and process control can be accurately predicted over time and spray gun consumable and wear part life can be more accurately included as part of the job costs.

MultiCoat Pro systems include and can control air lines for silvent air knives, spray gun air jets, venturis for part cooling or other air cooling needs.

For more information on the thermal spray guns that can be used with MultiCoat Pro, please refer to the data sheet specified in the following table:

Spray Gun Model	Data Sheet
Controlled Atmosphere Plasma	
SinplexPro 03C	DSE-0110
F4-VB	DSE-0112
Atmospheric Plasma	
TriplexPro-210	DSE-0062
SinplexPro series	DSE-0061
F4MB-XL series	DSE-0035
Metco 9MBM	DSE-0019
Metco 3MBM	DSE-0007
SM-F210	DSE-0058
Gas-Fuel HVOF	
Diamond Jet 2600	DSE-0026
Diamond Jet 2700	DSE-0026
Liquid Fuel HVOF	
WokaStar-610-Sz	DSE-0068
WokaJet-410-Sz	DSE-0067
Combustion Powder	
Metco 6P-II-A	DSE-0017
Combustion Wire	
Metco EGD-K	DSE-0111

All other Oerlikon Metco APS and HVOF machine-mount spray guns can be incorporated into a MultiCoat Pro system and are available upon request. Please contact your Oerlikon Metco Sales Representative for more information.

3.4 Material Feeders



MultiCoat Pro accommodates up to eight powder feeders, which can be operated simultaneously or independently.

The use of an OPC UA communication protocol allows powder feeders to be seamlessly "plug and play" integrated into the MultiCoat Pro system. OPC UA aids in fault identification, thereby increasing up time, and aids data analysis for Industry 4.0 (IIoT).

All feeder settings and functions are available through Clarity. Feeder choice, carrier gas and feed parameters are integrated into the recipe. The installed powder feeder models are recognized by Clarity, which sets operating limits accordingly.

All powder feeders for MultiCoat Pro are factory-equipped for use with atmospheric plasma spray, gas-fuel HVOF and liquid-fuel HVOF without the need to change hardware. Specialized feeder cabinet configurations are used for integration into the MultiCoat Pro system.

Powder feeders available for use with MultiCoat Pro are:

3.4.1 Single Pro Feeder

This feeder offers volumetric (disk) operation for all atmospheric, powder-fed thermal spray processes with exchangeable hoppers for the various processes. Hoppers are equipped with an RFID chip that ensures the correct hopper is used.

Two models are available. The standard Single Pro feeder provides accurate and robust volumetric feeding using proven feeding technology. The Single Pro G (gravimetric) feeder incorporates a load cell for closed-loop feed rates, set via the Clarity user interface.

Digital mass flow for the carrier gas (argon or nitrogen) ensures accurate carrier gas flow and rapid response rates. An additional mass flow controller can be purchased for high-feed rate applications.

3.4.2 Metco 9MPE-CL20 Feeder Series

Metco 9MPE-CL20 feeders incorporate fluidic bed technology with closed loop control of the carrier gas and feed rate. All feeder parameters can be set at the Clarity user interface.

For more information on these feeders, please refer to the data sheet specified in the following table:

Material Feeder Model	Data Sheet
Single Pro	DSE-0108
Metco 9MPE-CL20	DSE-0021

3.5 Process Management



Process management is compactly arranged within MultiCoat Pro, which can house functionality for up to three thermal spray processes.

A separate hardware module is used for each thermal spray process. This flexibility and modularity allows for very easy maintenance. A new process is quickly and easily installed into an existing MultiCoat Pro system.

Each process management module bi-directionally communicates with the Clarity user interface where process functions are visually displayed and controlled by the operator. Industry 4.0 (IIoT) functionality using the OPC UA protocol allows the system to be accessible via the customer's production and data networks.

Process management is equipped with an uninterruptible power supply (UPS). This allows the system to be safely shut down and recipes saved in the event of an unscheduled power interruption. In addition, a gas warning module can process up to eight gas safety sensors.

3.6 Gas Management



Gas management is accomplished, using modular plates, where each plate has the gas control functionality for a single thermal spray process.

The very modular design allows a new gas line, or even an entire gas plate, to be easily added to or replaced in an existing system and automatically recognized by the system and the Clarity user interface.

Previously, some gases required two mass flow controllers to accurately operate at the very low or very high gas flows needed for thermal spray processing. Now, MultiCoat Pro employs a single, state-of-the-art, dual-curve mass flow controller that accurately operates at all gas flow ranges. This more efficient design reduces hardware duplication and inventory costs.

Please refer to the table, "Gas Configuration Choices" for available customer-specified gas options for a MultiCoat Pro system. Custom gas flows and combinations are available on request.

3.7 Power Supply



MultiCoat Pro employs the Metco PTPro 120 power supply for atmospheric plasma spray operations. This power supply uses advanced technology for superb process stability that results in excellent coating reproducibility. Air-cooled and water-cooled models are available. The Metco PTPro power supply is designed for use with all compatible atmospheric plasma spray guns, including single- and triple-cathode cascading arc spray guns. Please see data sheet DSE-0106 for more information.

3.8 Universal Junction & Monitoring Unit



The new, state-of-the-art Universal Junction & Monitoring Unit replaces the previous JAMBox. One Junction & Monitoring Unit accommodates all Oerlikon Metco plasma spray guns that can be used with MultiCoat Pro, including both single cathode and triple cathode guns, thereby reducing system complexity when both triple cathode and single cathode guns are used on the same system. MultiCoat Pro ChamPro systems require a second Junction & Monitoring Unit.

3.9 Electrical Distribution



The electrical distribution system within the MultiCoat Pro monitors and controls the distribution of all electrical requirements for the system. The entire system uses a single power cable equipped with a power switch, which ensures that all components are powered down for maintenance and safety.

MultiCoat Pro includes an external voltage supply for the booth operational lighting, that is functional even when the main power switch for the machine is off.

Gas Configuration Choices

Process	Gas Options
Controlled Atmosphere Plasma Spray	Ar
	Ar, H ₂
	He
Atmospheric Plasma Spray	Ar, He
	Ar, H ₂
	Ar, H ₂ , N ₂
Gas-Fuel HVOF	Ar, H ₂ , N ₂ , He
	H ₂ , O ₂ , Air and N ₂ ^a
Liquid-Fuel HVOF	CH ₄ / Natural Gas, O ₂ , Air and N ₂ ^a , H ₂ ^b
Combustion Powder Spray	O ₂ , Kerosene
	H ₂ , O ₂ , Air
Combustion Wire Spray	C ₂ H ₂ , O ₂ , Air
Auxiliary Gases (standard)	Air ^c , Ar and N ₂ ^d

^a N₂ and air are switchable for shroud gas

^b Required for ignition

^c On/off pressure control for air jets, silvent air knives and venturis

^d Carrier gas

Note: other gas configurations may be available on request

3.9.1 Optional Electrical Distribution Equipment

Customers can optionally choose to have the MultiCoat Pro electrical distribution equipped with the Fuse Supervision and Energy Monitor package.

- **Fuse Supervision:** Supervises three-phase fuses for high-power consuming components and sub-systems, such as the dust collector, water chiller or power supply. Should a fuse fail, its location can be identified via the Clarity user interface, reducing downtime as faster fuse replacement can occur. Relevant data can also be sent over the customer's Industry 4.0 (IIoT) network.
- **Energy Monitor:** Monitors the complete electrical consumption of the system. This information is communicated to the Clarity user interface where it can be viewed by the operator and stored for off-line use using Clarity's trending and reporting features. The information is also accessible via the customer's data network or through the customer's Industry 4.0 (IIoT) network.

3.10 Heat Exchangers / Chillers



Customers should choose an appropriate heat exchanger or chiller for cooling of water-cooled spray guns (APS, HVOF, ChamPro). Additional cooling water will be required for the chamber of a ChamPro system.

Oerlikon Metco's System Sales team will assist in cooling water options.

4 Spray Gun and Workpiece Handling Systems

MultiCoat Pro and the Clarity user interface are more than just a spray controller. It is designed to be integrated into a complete thermal spray system, with the capability to manage and control the entire thermal spray process.

Every MultiCoat Pro spray system is designed with spray gun and workpiece handling systems that are customized for the specific workpiece geometries and production needs of the customer. Whether you require processing of single parts of many different configurations, batch processing of parts or fully-automated in-line continuous series production, our team of engineers can design a handling system that fits your unique production and application needs.

Oerlikon Metco can integrate popular brands of robots into the MultiCoat Pro system not only as spray gun manipulators, but also for workpiece transfer in fully automated spray lines. In addition, traverses and fully customized spray gun manipulators are possible. Robots can be track-mounted which can increase the range of workpiece sizes that can be accommodated or, for systems with multiple workpiece handling stations, move between stations.

We offer a wide-range of turntables for workpiece handling to accommodate workpieces of different sizes and weights,

with tilting and indexing options. Dual turntables are also possible, which allows parts to be loaded / unloaded while other parts are being sprayed.

Headstock-tailstock units for workpieces of practically any size and weight are available. As with spray gun manipulators, highly customized workpiece handling can also be engineered to suit the customer's needs.

For LPPS and LVPS systems, we can custom engineer single and multiple workpiece load-lock chambers, with optional preheat capability to transfer the workpiece in and out of the controlled atmosphere chamber without the need to break the vacuum in the main chamber. Such an arrangement allows for continuous production. Oerlikon Metco's 'sting' systems are most often chosen for spray gun manipulation.

For VPS systems, chambers can be outfitted with robots for spray gun manipulation and turntables or other equipment for workpiece manipulation specially equipped to withstand vacuum conditions.



MultiCoat Pro system with headstock-tailstock workpiece handling and track-mounted robot for spray gun handling

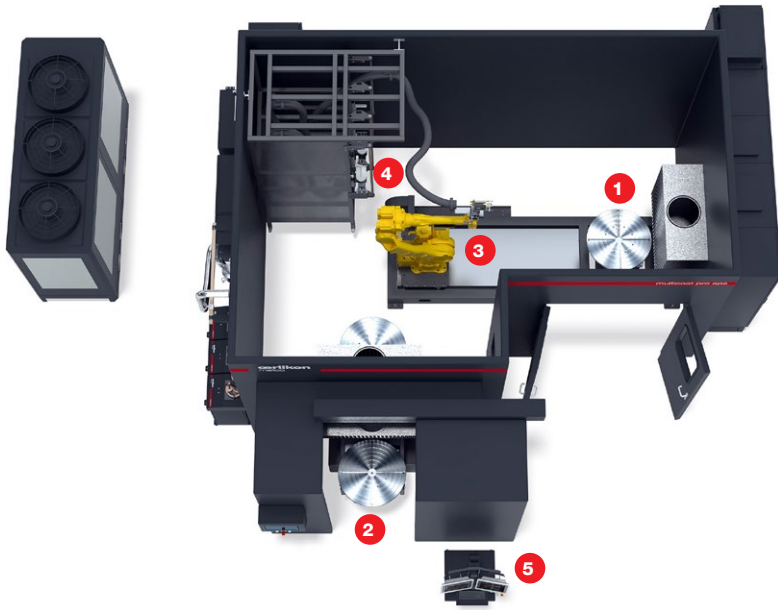

Overhead, cutaway view of dual workstation MultiCoat Pro system with ❶ single tilting-indexing turntable station, ❷ dual K2 turntable system, ❸ track-mounted robot, ❹ Automated gun station and ❺ Clarity user interface.

MultiCoat Pro LVPS controlled atmosphere system with dual load-lock transfer chambers for continuous production

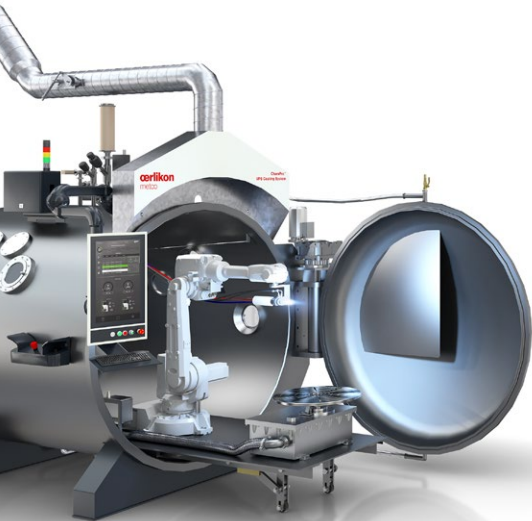

MultiCoat Pro VPS controlled atmosphere system with vacuum-hardened robot and turntable for batch production

MultiCoat Pro Process Cube.
(shown without spray booth)



5 Features and Benefits

Efficient

- Fully customizable, MultiCoat Pro's spray processes and handling systems are totally configurable to provide best efficiency for your unique requirements
- MultiCoat Pro systems can be designed for one-off work-piece processing, batch processing or in-line high-volume series production
- Advanced Clarity user interface guides operators through the thermal spray process, reducing time and training
- Customizable Clarity screens allows you to focus on process steps important to you
- If necessary, upgrades to add a spray gun, powder feeder or an entire process is fast and easy
- Improved trending and reporting system is easier to use and provides more information

Economical

- Multiple spray processes in the same system maximizes your investment and reduces floor space needed for thermal spray operations
- Improved user interface reduces navigation, thereby reducing processing time and learning curves
- Maintenance data helps prompt when spare parts and rebuilds are required, reducing guesswork and saving on spare part costs

6 System Options

6.1 Production Manager

At the heart of the Clarity User Interface lies the optional Production Manager module, that is designed to digitally manage the complete production process.

When installed, the Production Manager is the master of the entire MultiCoat Pro system and determines the function of each device in the coating process. Production Manager can be configured by the user for a very simplified and highly automated environment or a more complex environment should the user prefer a more manual operation mode.

Once the Production Manager has been setup up for one system, the data can then be exported and shared with similar systems within the production environment. The Production Manager provides all production relevant parameters to be available via the standard data transfer interfaces available with Clarity.

The Production Manager consists of the following main modules:

Effective

- Advanced thermal spray processing ready for Industry 4.0 (IIoT)
- New 'plug and play' structure makes adding additional processes or powder feeders simple and quick
- Use up to 8 powder feeders individually or simultaneously
- Powder feeders are equipped to handle all atmospheric MultiCoat Pro spray processes using powder as the feed-stock material, without the need to reconfigure the feeder or change feeders
- Reliably and repeatably apply thermal spray coatings using up to 5 different atmospheric spray processes using the same coating system
- Role and user security system is easy to customize to your company's security policies and operating standards
- Customizable parameter tolerances allows you to set up recipes that are more suitable for your applications

Environmental

- Designed and built to the latest safety standards
- Sophisticated warning and alarm system with easy to understand messaging
- User interface intelligently monitors system configuration for safer operating conditions
- Acoustical protection up to 75 dBA

6.1.1 Workpiece Creator and Database

Users can create and manage workpieces by enter production specific information that describes how the workpiece should be processed.

The workpiece entry in the database can be configured to include production-specific information such as checklists and operational procedures.

6.1.2 Fixture Creator and Database

A fixture is defined as the number of workpieces that can be processed in a single spray run. For example, a turntable fixture that holds up to 12 individual workpieces.

The user can create and manage fixtures by entering fixture-specific information such as number of holders, number of parts per holder, a picture, and more.

6.1.3 Workflow Creator and Database

A workflow is the complete step-by-step instructions for a complete spray process run and can include pre- and post-coat process steps. Using a wizard-type interface, the work-

flow creator guides through the process of creating a new workflow.

6.1.4 Production Run and Queue

A production run, in the simplest of terms, can be defined as the execution of a single fixture, containing one or more workpieces from the moment the booth door is closed prior to coating to the moment the door is reopened. However, the production run can handle far more complex situations, such as applications using multiple handling fixtures. For example, a 24 station handling system (one fixture for station) can all be processed in a single production run. The Production Run is comprised of all the workpieces to be coated, the respective fixtures and the workflows to be implemented.

The production queue determines the order of execution of various production runs. For example, for a workpiece that requires multiple coatings, the user can configure the production queue to apply one coating to all the workpieces followed by a second coating to all the workpieces. Alternatively, the production queue can be configured to coat each part with multiple coatings before moving on to the next workpiece.

6.2 Automated Gun Station

When multiple guns are used within a spray booth, the optional Automated Gun Station works in concert with the Production Manager to choose the correct spray gun for the chosen application. As the spray gun is set as a device within the Production Manager's Workpiece Creator / Database, the Production Manager will automatically check that the correct gun is enabled on the system. If it is not, it will automatically house the current gun and then choose the correct gun from the Automated Gun Station. Sensors ensure that the spray guns are properly disconnected from and coupled to the system before the work begins.

The Automated Gun Station can handle up to 5 spray guns. The spray guns can be for different thermal spray processes. For example, the station may house several HVOF spray guns, several plasma spray guns and a combustion powder spray gun.

6.3 Spray Sentry

Adds real-time spray plume diagnostics using the Tecnar Accuraspray 4.0 to measure:

- Particle velocity
- Particle temperature
- Spray plume intensity
- Spray plume position
- Spray plume geometry
- Spray plume density

The information received from spray diagnostics can be used to:

- Reduce parameter development time and cost
- Optimize spray parameters
- Improve spray quality and consistency
- Help prevent coating errors and costly rework

6.4 Data Access Box

The optional Data Access Box allows transmission of relevant data using OPC UA, ProfiNet or HTTP GET requests.

The Data Access Box can transmit the following data in 1 s intervals, including the target nominal, intermediate nominal, actual and tolerance data, where applicable:

- | | |
|------------------------------|----------------------------|
| ■ Current | ■ Air jet flow |
| ■ Voltage at power supply | ■ Silvent air knife flow |
| ■ Voltage at gun | ■ Exhaust air flow |
| ■ Power (net) | ■ Feeder carrier gas |
| ■ Electrical regulation mode | ■ Feeder hopper pressure |
| ■ Process / fuel gas flow | ■ Feeder vibrator pressure |
| ■ Shroud gas flow | ■ Feeder disk speed |
| ■ Cooling gas flow | ■ Feeder stirrer speed |
| ■ Cooling water flow | ■ Feeder powder flow |
| ■ Kerosene back pressure | |

Using the included web interface, a user with proper permissions can access the data from their workstation computer or a tablet with a compatible web browser.

The Data Access Box also allows data to be stored on an external network drive or other storage device for historical and quality control purposes.

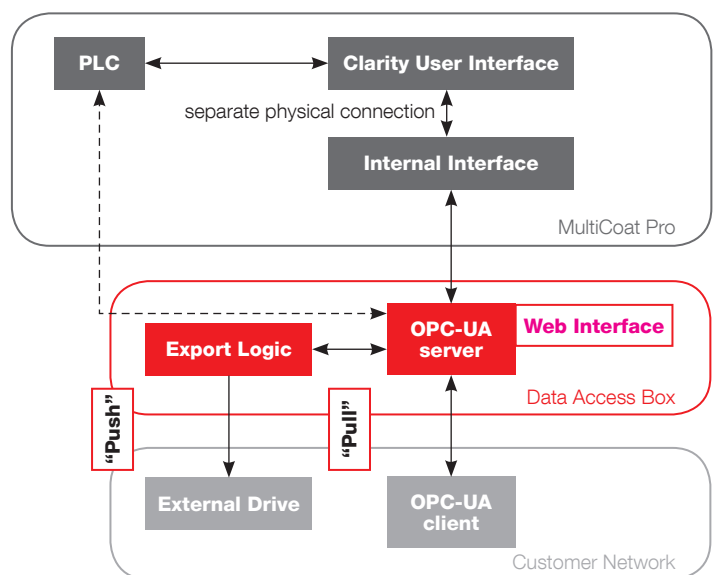

Data Access Box communication schematic

7 Technical Data

7.1 Specifications

Power Requirements

Input Voltage	3Φ	400 V, 440 V, 460 V, 480 V or 570 V
Frequency		50 / 60 Hz
Current	max	580 A

Cabinet Protection Ratings

Electrical Enclosures		IP 54
Gas Enclosures		IP 43

Environment

Temperature		10 to 40 °C	50 to 104 °F
Humidity		< 75%, non-condensing	
Floor Bearing Load Capacity	min	1000 kg/m ²	205 lb/ft ²
Noise Level	max (APS)	75 dBA @ 1 m	75 dBA @ 3.3 ft

Process Media Purity^b

Argon	Ar	99.998 %
Nitrogen	N ₂	99.999 %
Hydrogen	H ₂	99.998 %
Helium	He	99.998 %
Oxygen	O ₂	99.9 %
Methane / Natural Gas	CH ₄	96 %
Acetylene	C ₂ H ₂	99.6 %
Kerosene		Jet "A"

Air Requirements

Dust Allowance	particle size	< 0.1 μm	< 4 μin
	max	0.1 mg/m ³	6.2 E-09 lb/ft ³
Oil	max	0.01 mg/m ³	6.2 E-10 lb/ft ³

Water Quality

Conductivity		< 5 μS·cm ⁻¹
Hardness CaCO ₃		< 50 ppm
pH		6.6

^a See component data sheets for further specification

^b Required gases dependent on spray processes and customer gas configuration(s) chosen. Refer to table in section 4.2 for configurations and maximum gas flows.